

Biolux[®]

GERMICIDAL ULTRAVIOLET FIXTURES

Models 4, 6, 8, 15, 25 & 30 Watt Strip Fixture



ATLANTIC ULTRAVIOLET CORPORATION[®] SINCE 1963

Manufacturers / Engineers / Sales / Service
Germicidal Ultraviolet – Equipment & Lamps

375 Marcus Boulevard, Hauppauge, NY 11788
(631) 273-0500 • Fax: (631) 273-0771
Email: Sales@AtlanticUV.com

Shop Products at
AtlanticUltraviolet.com

Learn More at **Ultraviolet.com**



Installation, Operation & Maintenance

Read and Follow All
Safety Instructions.
Save These Instructions.

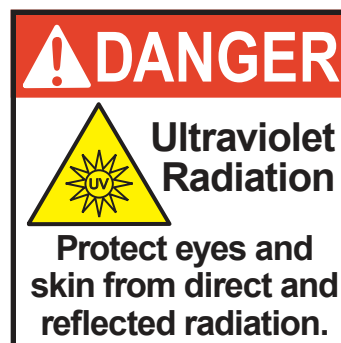

Owner's Manual

TABLE OF CONTENTS

SAFETY WARNINGS	3
SAFETY INSTRUCTIONS	3
SAFETY LABELS & SIGNS.....	3
CAUTION.....	4
PRODUCT APPLICATION	4
CONSTRUCTION	4
PRINCIPLE OF OPERATION	4
LIMITATION OF USE.....	4
UNPACKING	4
INSTALLATION	5
PRECAUTIONS	5
OPTIONAL ACCESSORIES	6
MAINTENANCE.....	6
BREAKAGE	6
DISPOSAL OF MERCURY ADDED LAMPS	6
TROUBLESHOOTING	7
TECHNICAL SPECIFICATIONS.....	7
REPLACEMENT PARTS.....	7
USER ASSISTANCE	8
PATENT NOTICE.....	8
WARRANTY & PRODUCT REGISTRATION	8

These instructions generally describe the installation, operation and maintenance of the **Biolux**[®] Germicidal Ultraviolet Fixtures. Questions that are not specifically answerable by these instructions should be directed to the factory. Atlantic Ultraviolet Corporation takes all possible precautions when packaging equipment to prevent damage. Carefully inspect and report all damages. Do not install damaged equipment. Follow all instructions on any labels or tags. Carefully inspect all packing materials before discarding to prevent the loss of accessories, mounting hardware, spare parts or instructions.

The information and recommendations contained in this publication are based upon data collected by the Atlantic Ultraviolet Corporation[®] and are believed to be correct. However, no guarantee or warranty of any kind, expressed or implied, is made with respect to the information contained herein. Specifications and information are subject to change without notice.





SAFETY WARNINGS

- All personnel should be alerted to the potential hazards indicated by the product safety labeling on this fixture.
- The following conventions are used to indicate and classify precautions in this manual and on product safety labeling. Failure to observe precautions could result in injury to people or damage to property.

 This is the safety alert symbol. It is used to alert you to potential personal injury hazards. Obey all safety messages that follow this symbol to avoid possible injury or death.

 **DANGER** Danger indicates an **IMMINENTLY** hazardous situation, which, if not avoided, **WILL** result in death or serious injury.

 **WARNING** Warning indicates a **POTENTIALLY** hazardous situation, which, if not avoided, **COULD** result in death or serious injury.

 **CAUTION** Caution indicates a **POTENTIALLY** hazardous situation, which, if not avoided, **MAY** result in minor or moderate injury.

 **CAUTION** Caution used without the safety alert symbol indicates a potentially hazardous situation, which, if not avoided, may result in property damage.

 This symbol is used to identify an **ELECTRICAL SHOCK** or **ELECTROCUTION** hazard.

 This symbol is used to identify an **ULTRAVIOLET LIGHT** hazard.

 This symbol is used to identify the need to wear approved ultraviolet blocking eyewear.

 This symbol is used to identify the need to wear approved ultraviolet blocking face shield.



 This symbol is used to identify the need to wear protective gloves.





 This symbol is used to identify components which must not be disposed of in trash

SAFETY INSTRUCTIONS

 **WARNING** To guard against injury, basic safety precautions should be observed, including the following:

1. Read and follow **ALL** safety instructions.

   **WARNING** Avoid exposure to direct or reflected germicidal ultraviolet rays. Germicidal ultraviolet rays are harmful to the eyes and skin.

2. Intended for indoor use only.
3. Do not alter design or construction.
4. Do not use this fixture for other than its intended purpose, as described in this manual.
5. Do not mount under any source of moisture or condensation, such as humidifiers, cooling coils, etc.
6. Do not remove any labels or devices.
7.  **CAUTION** Germicidal ultraviolet rays may break down plastic, rubber or other non-metallic materials, with inadequate resistance to ultraviolet. Shield all plastic, rubber or other non-metallic parts such as; plastic drain pans, wire insulation, flex ducts, humidifiers, filters, etc. which may be exposed to direct or reflected germicidal ultraviolet rays.
8.   **WARNING** Do not operate without proper electrical ground.
9. Do not operate the fixture if there is visible or suspected damage to the fixture or, if applicable, there is damage to power cord and/or plug.
10. Utility power supplied, to the fixture, **MUST** match power requirements listed on the fixture label.
11.   **WARNING** Always disconnect power to the fixture before performing any service or maintenance.
12. Read and follow all notices and warnings on the fixture.
13. **SAVE THESE INSTRUCTIONS.**

SAFETY LABELS & SIGNS

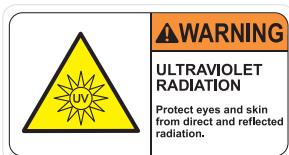

Danger Label: UV Radiation (70-0052)



Hg - Lamp Contains Mercury (70-0011)

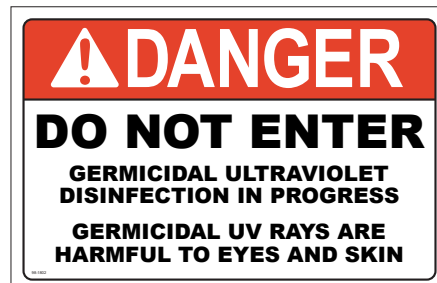

Post supplied Danger Signs on all access doors to the area where treatment will take place.



Warning Germicidal UV (70-0037)



Location of Danger Labels

- 8.5" x 5.5"
- 2-Sided (English / Spanish)
- 2 Supplied
- Item Number: 98-1802

CAUTION

It is the user's responsibility to determine and validate the suitability of this equipment for use in the user's system or process. No warranty or representation is made by the manufacturer with respect to suitability or performance of this equipment or to the results that may be expected from its use. The user should periodically inspect, clean as necessary and confirm the presence and good legibility of the product safety labels. Contact the factory for replacement labels in the event that any of the labels are missing or illegible.

PRODUCT APPLICATION

CONSTRUCTION

The **Biolux**® Germicidal Ultraviolet Fixture consists of:

- **STER-L-RAY**® Germicidal Ultraviolet Lamp, which delivers ultraviolet energy at the specific wavelength of 254 nanometers (nm). This wavelength is highly effective against microbes including: virus, bacteria, and mold spores.
- **Surelite**™ Electronic Ballast capable of operating at 120 volts 60 hertz or 230 volts 50 hertz.
- All electrical parts and wiring are housed in an enclosure constructed of chrome-plated steel.

PRINCIPLE OF OPERATION

The **Biolux**® line of UV-C fixtures has been carefully conceived to provide germicidal UV exposure for air or surface disinfection. The dosage, as it applies to UV disinfection, is determined by the time and intensity the air or surface is exposed to UV light.



⚠ WARNING Avoid exposure to direct or reflected germicidal ultraviolet rays. Germicidal ultraviolet rays are harmful to the eyes and skin.

LIMITATION OF USE

- The **Biolux**® Germicidal UV Fixtures **MUST** comply with applicable state, local, and national electrical and mechanical codes.
- **Biolux**® requires knowledgeable planning for: location, installation, and supervision to prevent ultraviolet exposure of personnel to direct or reflected ultraviolet rays. Overexposure to germicidal ultraviolet rays will result in the irritation of the eyes and reddening of the skin.

⚠ CAUTION Overexposure to germicidal ultraviolet rays will result in the irritation of the eyes and reddening of the skin.

For this reason, it is of the utmost importance that your ultraviolet application be carefully planned and implemented so as to avoid exposure of occupants, to direct or reflected ultraviolet rays.

- The American Conference of Governmental Industrial Hygienists (ACGIH) has established that the ultraviolet radiant exposure incident for unprotected eyes or skin should not exceed 0.2 microwatts per square centimeter ($\mu\text{W}/\text{cm}^2$) at 254 nanometers (nm) for an eight (8) hour period. ("2004 TLVs® and BEIs®")*
- Safety and maintenance procedures **MUST** be implemented to prevent accidental exposure of personnel. All work performed in the irradiated space must be monitored to ensure that it does not adversely impact the safety or effectiveness of the installation.
-  Personal protection equipment is required when entering the irradiated space with the germicidal lamp operating. Personal protection equipment includes skin and eye protection such as gloves, long sleeves with no gaps between cuff and gloves, and an ultraviolet resistant face shield.
- To monitor and test ultraviolet intensity, see "**Zenith**™ Germicidal Ultraviolet Detector" on **Page 6** for further details.

UNPACKING

- Remove the **Biolux**® Germicidal Ultraviolet Fixture from its shipping carton.
- Atlantic Ultraviolet Corporation® takes all possible precautions when packaging this fixture to prevent damage. Carefully inspect the fixture, power cord and plug if applicable, for damage. Report all damage immediately. Do not assemble or operate if there is any damage, visible or suspected.
- The UV-C lamp is in with the fixture to ensure maximum protection for the lamp. Keep lamp aside until ready for installation. When installing, avoid touching glass with bare hands. Oils deposited, from fingers, on the glass could effect UV transmission.
- Carefully inspect all packing materials to prevent the loss of accessories, mounting hardware, spare parts or instructions.
- Do not discard packing materials until fixture is assembled and check out is complete.

The **Biolux**® Germicidal Ultraviolet Fixture includes:

- 1 - Germicidal UV Fixture with attached 5-ft lead cord (approx.)
- 2 - **Promate**™ Danger Signs (98-1802)
- 1 - **STER-L-RAY**® Germicidal Ultraviolet Lamp
- 1 - Installation and Operation Manual

* The Threshold Limit Values (TLVs®) and Biological Exposure Indices (BEIs®) are developed as guidelines to assist in the control of health hazards. These recommendations or guidelines are intended for use in the practice of industrial hygiene, to be interpreted and applied only by a person trained in this discipline. They are not developed for use as legal standards and ACGIH® does not advocate their use as such. However, it is recognized that in certain circumstances, individuals or organizations may wish to make use of these recommendations or guidelines as a supplement to their occupational safety and health program. ACGIH® will not oppose their use in this manner, if the use of TLVs® and BEIs® in these instance will contribute to the overall improvement in worker protection. However, the user must recognize the constraints and limitations subject to their prior use and bear the responsibility for such use. (from acgih.org website)

INSTALLATION

CAUTION Access to area MUST be avoided when **Biolux**[®] fixture is operating.



IN ORDER TO PERFORM THIS TASK, BE SURE TO WEAR THE FOLLOWING SAFETY EQUIPMENT: SAFETY GLASSES OR A FACE SHIELD, AS WELL AS GLOVES.

WARNING Always disconnect power to the fixture before performing any service or maintenance.

CAUTION Ultraviolet lamp is easily damaged and may cause injury if broken. Exercise care when handling.

- For all standard **Biolux**[®] fixtures:
 - Remove lamp by turning 90° so pins on each end are vertical to opening at top of lampholders. Lift lamp out of lampholders.
 - Fixture should be located within 5 feet of an electrical outlet.
 - Fixture should be easily accessible with enough room for routine cleaning and maintenance.
 - Mounting holes available for surface mount (See **Figure 1**).
 - Reattach cover to base.
- After the fixture is mounted, **install lamp**. Line up the contact pins, of the lamp, with the openings in the lampholders. Make sure that the contact pins are inserted into both lampholders. Once the pins are in, turn the lamp a ¼ turn (90°) and the lamp should “snap” into place.
- Verify that the lamp is properly seated.
- Moisten a clean, lint-free cloth with denatured alcohol and clean lamp.



WARNING Avoid exposure to direct or reflected germicidal ultraviolet rays. Germicidal ultraviolet rays are harmful to the eyes and skin.

Use personal protection equipment, such as gloves, long sleeves with no gaps between cuffs and gloves, and ultraviolet resistant face shield, when exposed to ultraviolet rays or when troubleshooting the **Biolux**[®] fixture.



- Apply power to the **Biolux**[®] fixture.
-   Verify operation by viewing lamp, use of personal protection equipment is required. If the fixture is not operating properly, go to “**Troubleshooting**” section on **Pages 6–7**.

Figure 1 – **Biolux**[®] 40-1109 Strip Fixture



PRECAUTIONS

- Procedures MUST be adopted to ensure that the **Biolux**[®] is disconnected from power whenever anyone (personnel, contractors, etc.) work in the irradiated space. Personnel who work in and around the fixture MUST be briefed on the precautions to be observed.
- If there are any doubts or concerns about the safety or the effectiveness of the installation, or if a sensitive ultraviolet meter is required, please contact our Application Specialists. (See “**Zenith**[™] **Germicidal Ultraviolet Detector**” in the “**Optional Accessories**” section on **Page 6**)

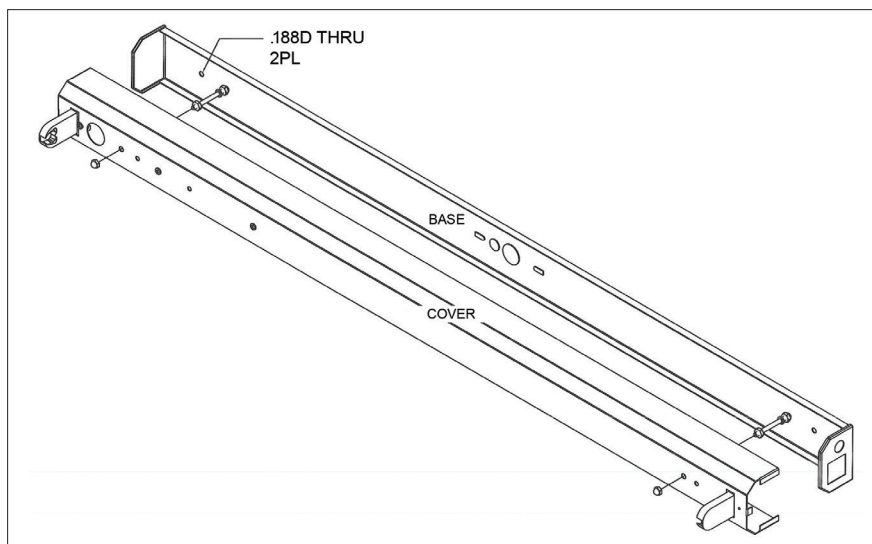
OPTIONAL ACCESSORIES

1. **ArmorLite™ Germicidal Ultraviolet Lamp Safety Shield:** A protective coating applied to **STER-L-RAY®** Germicidal Ultraviolet Lamps that ensures protection by eliminating the dangers associated with fragments of broken quartz and mercury contamination.
2. **Zenith™ Germicidal Ultraviolet Detector (30-1015):** A sensitive, hand-held, self-contained battery operated ultraviolet meter that can be used for:
 - Monitoring UV-C Germicidal Lamp Intensity & Aging
 - Measuring UV-C Germicidal Fixture Leakage
3. **Promate™ Safety Glasses (00-0126):** Safety eyewear **MUST** be used as general-purpose safety protection and for additional shielding from ultraviolet rays
4. **Promate™ Face Shield (00-1299):** Lightweight visor with adjustable headgear provides eye and face protection from germicidal ultraviolet rays.
5. **Promate™ Danger Signs (98-1802):** Glossy card stock 5.5" x 4.25" signs to be affixed to entry door(s) to warn that an ultraviolet sanitizer is in use and that the treatment area **MUST** not be entered. **Biolux®** is for use only in **unoccupied** areas. Two (2) signs are included with each model; additional signs may be purchased. **NOTE:** Danger Signs have English on one side and Spanish on the other.
6. **Assure™ UV-C Dosimeter (00-0376):** A portable, full-featured instrument that provides highly-accurate UV-C measurements in mJ/cm². Sits upright, on back or side, and can be placed in supplied wall holder. Uses 1 AAA battery.
7. **UV-C Dosimeter Card (00-0373):** Contains a patented colorimetric indicator that changes color at 25, 50, and 100 mJ/cm² to visibly confirm that your **Biolux®** is achieving the desired UV-C exposure. Each card is designed for one (1) treatment cycle and **CANNOT** be reused. Complete instructions for use are on back of card.
8. **Personal UV-C Exposure Indicators (00-0375):** These indicators change color to reveal the word "STOP" if personnel are exposed to an accumulated dose of 6 mJ/cm² of UV-C irradiation. Adhesive backing sticks to clothing. Available in packs of 10. Designed for single, daily use and **CANNOT** be reused.

For more information and purchasing, contact our offices weekdays between 8:30 am and 5:00 pm Eastern time at: Atlantic Ultraviolet Corporation®, 375 Marcus Boulevard, Hauppauge, New York, 11788 • Tel: (631) 273-0500 • Fax: (631) 273-0771
Email: Sales@AtlanticUV.com • Shop: AtlanticUltraviolet.com • Learn More: Ultraviolet.com

MAINTENANCE

 **⚠ WARNING** Always disconnect power to the fixture before performing any service or maintenance.

- The **Biolux®** is designed to operate with a minimal amount of maintenance.
- A regular cleaning schedule of the germicidal lamp **MUST** be established, and carefully maintained, based on visual inspection and experience. The time between cleanings will vary with the conditions surrounding each installation. It is recommended that the ultraviolet lamp be cleaned whenever dust or visible deposits are observed on lamp.
- The germicidal ultraviolet lamps used in the **Biolux®** have a manufacturer's rated average effective life of 6,000 hours, and 8,000 hours (depends on lamp; See Chart in "Technical Specifications" on Page 7). Lamps may operate longer than their rated effective life, but the reduction in ultraviolet output will make it impractical to use past the manufacturer's rated life. For maximum efficiency, lamp replacement is recommended every 6,000 or 8,000 hours of continuous operation.
- See "Installation" instructions on Page 5 for proper germicidal lamp replacement and cleaning procedure.

BREAKAGE

 **⚠ CAUTION** Broken Quartz is SHARP.



Wear protective gloves when handling broken ultraviolet lamp(s). In the event of breakage, **DO NOT** use a household vacuum cleaner to pick up quartz fragments. Sweep up debris into a plastic bag and dispose of properly.

DISPOSAL OF MERCURY ADDED LAMPS



Germicidal ultraviolet lamps, like standard fluorescent lamps, contain small amounts of mercury. Mercury added lamps should not be placed in the trash. Dispose of properly. For further information regarding the disposal and recycling of lamps containing mercury, along with Federal and State requirements visit LampRecycle.org. For more information on **STER-L-RAY®** Germicidal Ultraviolet Lamps, visit AtlanticUltraviolet.com or Ultraviolet.com.

TROUBLESHOOTING

 **WARNING** Always disconnect power to the fixture before performing any service or maintenance.



IN ORDER TO PERFORM THIS TASK, BE SURE TO WEAR THE FOLLOWING SAFETY EQUIPMENT: SAFETY GLASSES OR A FACE SHIELD, AS WELL AS GLOVES.

IMPORTANT: This fixture is to be serviced **ONLY** by qualified and appropriately licensed personnel.

Table 1 – Troubleshooting

Problem	Possible Cause	Corrective Action
Fixture not operating	No electrical power	Verify that the fixture is connected to a live power source.
	Power connections, to fixture, loose or disconnected	Verify power connections to fixture are fully engaged.
STER-L-RAY® Germicidal Ultraviolet Lamp not operating	STER-L-RAY® Germicidal Lamp not properly seated	Confirm connection between lamp and lampholder is tight, and that lamp is making full contact with lampholder.
	STER-L-RAY® Germicidal lamp faulty	Swap suspect lamp, with lamp known to be good. If suspect lamp does not operate, replace lamp.
	Surelite™ Ballast not functioning	Locate ballast and replace.

If the above measures fail to correct the problem(s), contact our application specialists. Contact options can be found in the “User Assistance” section of this manual on Page 8.

TECHNICAL SPECIFICATIONS

Table 2 – Technical Specifications

Model:	4 Watt	6 Watt	8 Watt	15 Watt	25 Watt	30 Watt	
Volts: ①	120v	120v	120v	120v	120v	120v	
Hertz:	60Hz	60Hz	60Hz	60Hz	60Hz	60Hz	
Amps:	0.10	0.12	0.16	0.15	0.25	0.33	
Lamp	Lamp:	05-1110-R	05-1109-R	05-1108-R	05-1105-R	05-1107-R	05-1106-R
	Power Consumption: ②	4.6w	5.9w	7.9w	14.7w	25.0w	30.5w
	Ultraviolet Output: ③	0.8w	1.6w	2.5w	4.8w	6.9w	11.6w
	Ave. Effective Life: (Hrs)	6,000	6,000	6,000	8,000	8,000	8,000
Length: (in)	9"	12"	15"	19-1/2"	19-1/2"	37-1/2"	
Width: (in)	1-3/8"	1-3/8"	1-3/8"	2-5/8"	2-5/8"	2-5/8"	
Height: (in)	2-3/16"	2-3/16"	2-3/16"	3-1/2"	3-1/2"	3-1/2"	

① 230v 50Hz fixtures are available. Consult Factory with voltage requirements.

② Wattage is lamp watts only and does not include ballast loss.

③ Ultraviolet output at 254nm at 100 hours and 80°F (approximate).

All specifications, dimensional data, etc. are approximate and subject to change without notice.

REPLACEMENT PARTS

Table 3 – Replacement Parts

Model:	4 Watt	6 Watt	8 Watt	15 Watt	25 Watt	30 Watt
STER-L-RAY® Germicidal Lamp	05-1110-R	05-1109-R	05-1108-R	05-1105-R	05-1107-R	05-1106-R
Surelite™ Ballast – 120v/60Hz	10-0166	10-0166	10-0166	10-0239	10-0167	10-0165
Steadfast™ Lampholder	05-1322	05-1322	05-1322	05-1324	05-1324	05-1324
Promate™ Lead Cord 120v	35-1100	35-1100	35-1100	35-1100	35-1100	35-1100

USER ASSISTANCE

Atlantic Ultraviolet Corporation® makes every effort to ensure that the **Biolux**® Germicidal Ultraviolet Fixture is a product of superior quality and workmanship. This manual describes the installation, operation and maintenance of the **Biolux**® Germicidal Ultraviolet Fixture.

Please read and become familiar with the contents of this manual before installing or using this fixture. If after reading the manual you still have questions, or concerns, regarding the installation or use of this fixture, contact our offices, weekdays between 8:30 am and 5:00 pm Eastern Time, at:

Atlantic Ultraviolet Corporation®
375 Marcus Boulevard
Hauppauge, New York, 11788
Tel: (631) 273-0500
Fax: (631) 273-0771
Email: Sales@AtlanticUV.com
Shop: AtlanticUltraviolet.com
Learn More: Ultraviolet.com

PATENT NOTICE

No attempt has been made to determine the patent status of applications illustrated or described in this publication. Inclusion in this publication of any design or method of use, which may be patented, is not to be construed as promoting or sanctioning unauthorized use.

WARRANTY & PRODUCT REGISTRATION

We warrant this product to the original owner to be free from defects in material and workmanship when installed in accordance with Atlantic Ultraviolet Corporation® specifications for a period of time as follows:

UV Water Purifier Chambers – Type 316 stainless steel chambers will have a Twelve (12) year Limited Warranty on the stainless steel chamber, from the date of original purchase while the Type 304 stainless steel chambers will have a Six (6) year Limited Warranty on the stainless steel chamber.

UV Air Disinfection Housing – Three (3) year Limited Warranty on the metal housing, from the date of original purchase.

Ballasts – Three (3) year Limited Warranty, from the date of original purchase.

UV Lamps, Monitoring Devices, Optional Accessories, and Other Parts – One (1) year Limited Warranty from the date of original purchase.

Within the warranty period we shall repair or replace such products, which are returned to us with shipping charges prepaid and which are determined by us to be defective. This warranty will not apply to any product, which has been subjected to misuse, negligence or accident; or misapplied; or modified; or repaired by unauthorized person; or improperly installed. Warranty will be null and void if any of the product's original labels are removed. This Limited warranty excludes the cost of labor.

The Buyer shall inspect the product promptly after receipt and shall notify us at our main office in writing of claims, including claims of breach of warranty, within thirty (30) days after the Buyer discovers or should have discovered the facts upon which the claim is based. Failure of the Buyer to give written notice of a claim within the time period shall be deemed to be a waiver of such claim.

The provisions of the above warranty are our sole obligation and exclude all other remedies or warranties, expressed or implied, including warranties of merchantability and fitness for a particular purpose, whether or not purposes or specifications are described herein. We further disclaim any responsibility whatsoever to the customer, or to any person for injury to person, damage to, or loss of property or value caused by any product which has been subjected to misuse, negligence, accident; or modified or repaired by unauthorized persons; or improperly installed.

Under no circumstances shall the Company be liable for any incidental, consequential or special damages; losses or expenses arising from the contract for this product, or in connection with the use of, or inability to use, our product for any purpose whatsoever.

Be sure to register your product and validate purchase within 30 days — registration is simple and will take less than 2 minutes to do.

NOTE – failure to register your purchase may jeopardize warranty.

Go to AtlanticUltraviolet.com and scroll down to the bottom of the page, under “Trust” click the “Warranty Registration Form”, complete and click “Submit”. Or click on “Warranty Registration PDF” to download the warranty registration card as a PDF, complete and mail to us at 375 Marcus Boulevard, Hauppauge, NY 11788, or simply fax to (631) 273-0771. If you prefer to register by phone, please call (631) 273-0500 and our customer service staff will be glad to assist you.

For your convenience, record the following information below. The model and serial number can be found on a label located on the **Biolux**® Germicidal Ultraviolet Fixture. Keep this manual, along with proof of purchase, handy when contacting our offices.

Purchased From:	Date:
Model:	Serial No.: