

Bio-Logic[®]

Available with *Pure Water Pack*[™]

GERMICIDAL ULTRAVIOLET WATER PURIFIERS

Models	Ballast 120v 50/60 Hz	Ballast 230v 50/60Hz
BIO 1.5	10-0518A	10-0514A
BIO 3.0	10-0518A	10-0514A



**ATLANTIC ULTRAVIOLET
CORPORATION[®]** SINCE 1963

Manufacturers / Engineers / Sales / Service
Germicidal Ultraviolet – Equipment & Lamps

375 Marcus Boulevard, Hauppauge, NY 11788
(631) 273-0500 • Fax: (631) 273-0771
Email: Sales@AtlanticUV.com

Shop Products at
AtlanticUltraviolet.com

Learn More at **Ultraviolet.com**



Installation, Operation & Maintenance

**Read and Follow All
Safety Instructions.
Save These Instructions.**

Owner's Manual

TABLE OF CONTENTS

SAFETY WARNINGS.....	3
SAFETY INSTRUCTIONS.....	3
SAFETY LABELING.....	3
CAUTION.....	4
PRODUCT APPLICATION.....	4
CONSTRUCTION.....	4
PRINCIPLE OF OPERATION.....	4
LIMITATION OF USE.....	4
WATER QUALITY.....	4
INSTALLATION.....	5-8
LOCATION.....	5
DIMENSIONAL DATA.....	5
RECOMMENDED INSTALLATION.....	6
INSTALLATION: BIO 1.5 AND BIO 3.0 120v 50/60Hz (BALLAST NO.10-0518A)	7-8
INSTALLATION: BIO 1.5 AND BIO 3.0 230v 50/60Hz (BALLAST NO.10-0514A)	7-8
RECOMMENDED OPTIONS.....	8
MAINTENANCE.....	9-13
INSPECTION.....	9
LAMP INSTALLATION OR REPLACEMENT: BIO 1.5 AND BIO 3.0 120v 50/60Hz (BALLAST NO.10-0518A)	10
LAMP INSTALLATION OR REPLACEMENT: BIO 1.5 AND BIO 3.0 230v 50/60Hz (BALLAST NO.10-0514A)	10
QUARTZ SLEEVE INSTALLATION, CLEANING OR REPLACEMENT.....	11
REPLACEMENT OF BROKEN QUARTZ SLEEVE.....	12
DISPOSAL OF MERCURY ADDED LAMP.....	13
TROUBLESHOOTING.....	13
TECHNICAL SPECIFICATIONS.....	14
OPTIONAL ACCESSORIES.....	14
REPLACEMENT PARTS.....	15
USER ASSISTANCE.....	16
PATENT NOTICE.....	16
WARRANTY & PRODUCT REGISTRATION.....	16

These instructions generally describe the installation, operation and maintenance of the **Bio-Logic**® Ultraviolet Water Purifiers, Models BIO 1.5 and BIO 3.0 using ballast no. 10-0518A and 10-0514A. Questions that are not specifically answered by these instructions should be directed to the Factory.

Atlantic Ultraviolet Corporation takes all possible precautions when packaging equipment to prevent damage. Carefully inspect and report all damages. Do not install damaged equipment.

Follow all instructions on any labels or tags. Carefully inspect all packing materials before discarding to prevent the loss of accessories, mounting hardware, spare parts or instructions.

The information and recommendations contained in this publication are based upon data collected by the Atlantic Ultraviolet Corporation® and are believed to be correct. However, no guarantee or warranty of any kind, expressed or implied, is made with respect to the information contained herein. Specifications and information are subject to change without notice.





SAFETY WARNINGS

- All personnel should be alerted to the potential hazards indicated by the product safety labeling on this unit.
- The following conventions are used to indicate and classify precautions in this manual and on product safety labeling. Failure to observe precautions could result in injury to people or damage to property.

 This is the safety alert symbol. It is used to alert you to potential personal injury hazards. Obey all safety messages that follow this symbol to avoid possible injury or death.

 **DANGER** Danger indicates an **IMMINENTLY** hazardous situation, which, if not avoided, **WILL** result in death or serious injury.

 **WARNING** Warning indicates a **POTENTIALLY** hazardous situation, which, if not avoided, **COULD** result in death or serious injury.

 **CAUTION** Caution indicates a **POTENTIALLY** hazardous situation, which, if not avoided, **MAY** result in minor or moderate injury.

 **CAUTION** Caution used without the safety alert symbol indicates a potentially hazardous situation, which, if not avoided, may result in property damage.

 This symbol is used to identify an **ELECTRICAL SHOCK** or **ELECTROCUTION** hazard.

 This symbol is used to identify an **ULTRAVIOLET LIGHT** hazard.

 This symbol is used to identify the need to wear approved ultraviolet blocking eyewear.









 This symbol is used to identify the need to wear approved ultraviolet blocking face shield.

 This symbol is used to identify the need to wear protective gloves.

 This symbol is used to identify components which must not be disposed of in trash

SAFETY INSTRUCTIONS

 **WARNING** To guard against injury, basic safety precautions should be observed, including the following:

1. Read and follow **ALL** safety instructions.
2. Do not use this water purifier for other than its intended purpose as described in this manual.
3. Do not alter design or construction.
4. Do not remove any labels or devices.
5.   **DANGER** To prevent the risk of severe or fatal electrical shock, special precautions must be taken since water is present near electrical equipment. **Always disconnect power before performing any service or maintenance.**
6.   **WARNING** Avoid exposure to direct or reflected germicidal ultraviolet rays. Germicidal ultraviolet rays are harmful to the eyes and skin.
7. Intended for indoor use only. The water purifier should be protected from the elements and from temperatures below freezing.
8. Do not operate water purifier if lamp cable, lamp connection, power cord and/or plug are damaged, or if any other damage to the water purifier is visible or suspected
9. Electrical power supplied, to the water purifier, **MUST** match power requirements listed on the water purifier.
10.   **DANGER** Plug the water purifier only into an approved ground fault circuit interrupt (GFCI) receptacle.
11.   **DANGER** Do not operate without proper electrical ground.
12. Do not exceed water purifier's maximum rated flow capacity.
13. Do not exceed maximum operating pressure of 100 PSI.
14. Read and follow all notices and warnings on the water purifier.
15. **SAVE THESE INSTRUCTIONS.**

SAFETY LABELS

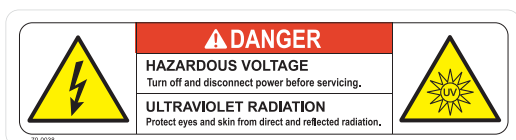

Danger Label: Hazardous Voltage and / Radiation (70-0038)

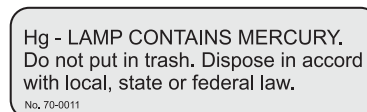

Hg - Lamp Contains Mercury (70-0011)

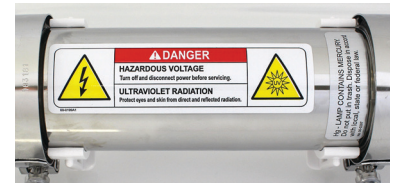

Location of Safety Labels

CAUTION

It is the user's responsibility to determine and validate the suitability of this equipment for use in the user's system or process. No warranty or representation is made by the manufacturer with respect to suitability or performance of this equipment or to the results that may be expected from its use. The user should periodically inspect, clean as necessary and confirm the presence and good legibility of the product safety labels. Contact the factory for replacement labels in the event that any of the labels are missing or illegible.

PRODUCT APPLICATION

CONSTRUCTION

- The water purifier is designed to mount horizontally.
- The water purifier's dual chamber heads are removable and may be rotated independently, which aids in the installation, maintenance, or retrofitting of an existing system.
- The water purifier's chamber and chamber head are passivated and electropolished type 316 Stainless Steel.
- **EASY-OFF™** End Caps enable quick and easy lamp change, without disconnecting from the water supply or draining the purifier. No tools are required. **Always disconnect electrical power when changing lamp.**

PRINCIPLE OF OPERATION

The **Bio-Logic®** design has been carefully conceived to provide adequate germicidal dosage throughout the disinfection chamber. The dosage, as it applies to ultraviolet disinfection, is a function of time and the intensity of ultraviolet radiation to which the water is exposed. The exposure time, in seconds, is the total time it takes the water to flow through the disinfection chamber exposing it to the germicidal lamp. Exposure time is related to the flow rate; the higher the flow rate, the lower the exposure time or the lower the flow rate, the higher the exposure time. The ultraviolet intensity is the amount of energy, per unit time, emitted by the germicidal lamp. The dosage is the product of ultraviolet intensity and the exposure time. The operation of the **Bio-Logic®** is as follows:

- Water enters the purifier and flows into the annular space between the quartz sleeve and the chamber wall.
- Suspended microorganisms are exposed to the ultraviolet rays emitted by the germicidal lamp.
- The LED indicator light, located on the ballast, provides visual indication of germicidal lamp operation.
- Water leaving the purifier is instantly ready for use, no further contact time is required.

LIMITATION OF USE

The water purifier is intended for the use with visually clear water, not colored, cloudy or turbid. See "**Water Quality**" section below. The water purifier is **NOT** intended for the treatment of water that has an obvious contamination or intentional source, such as raw sewage; nor is the unit intended to convert wastewater to microbiologically safe drinking water.

WATER QUALITY

Water quality plays a major role in the transmission of germicidal ultraviolet rays. It is recommended that the water does not exceed the following maximum concentration levels:

Table 1 - Maximum Concentration Levels

Turbidity	< 1 NTU
Manganese	0.05 mg/l
Total Suspended Solids	10 mg /l
pH:	6.5 - 9.5
Color:	None
Hardness	6 GPG or 102.6 PPM
Iron	0.3 mg/l
Tannins:	< 0.1 ppm (0.1 mg/l)
UV Transmission	>85% per cm*

* Contact Factory for recommendations on applications where UV transmission is < 85%

Effectively treating water with higher concentration levels than listed above can be accomplished, but may require added measures to improve water quality to treatable levels. If, for any reason, it is believed the ultraviolet transmission is not satisfactory, contact the factory.

INSTALLATION

LOCATION

1. The water purifier is intended for indoor use only. The water purifier is designed to mount horizontally. The water purifier should be protected from the elements and from temperatures below freezing. The ambient temperature, in the area surrounding the water purifier, should be between 35°F and 100°F.
2. Electrical power supplied to the water purifier **MUST** match power requirements listed on the water purifier. Use of a voltage surge protector is recommended.
3. **⚠ CAUTION** Install water purifier within 48" of a known good ground. Water Purifier will need to be installed into approved ground fault circuit interrupt (GFCI) receptacle. Where a 2-prong or unprotected 3-prong receptacle is encountered, it must be replaced by a properly grounded Ground Fault Circuit Interrupt (GFCI) receptacle. Installation must be in accordance with the National Electrical Code and any local codes and ordinances by a qualified electrician.
4. The water purifier should be located in a dry, well-lit area, which provides enough room to perform routine maintenance. This includes a minimum distance of one chamber length from the chamber end, to allow for cleaning and/or the changing of the lamp and quartz sleeve as well as a minimum of 6" on the opposite end of the water purifier. Minimum clearance to floor 18".
5. The water purifier should always be located closest to the point of use. This reduces the chance of the purified water being re-contaminated by bacteria in the water distribution system after the water purifier.
6. **⚠ CAUTION** As with any water handling device, the water purifier should be located in an area where any possible condensation or leakage from the water purifier, any purifier accessory and/or plumbing will not result in damage to the area surrounding the water purifier. **For added protection, it is recommended that a suitable drain pan be installed under the purifier. The drain pan must be plumbed to an adequate, free flowing drain to prevent water damage in event of a leak. There are numerous leak detection/flood stop devices, available on the market today, designed to stop flow of water, reducing the chance of water damage due to leakage. For more details regarding leak prevention and/or limiting damages due to leaks please contact factory.**
7. The water purifier should be located after all other water devices, such as De-ionizers, Water Softeners, Carbon Filters, Pre-Filters, Reverse Osmosis, Pressure Tanks, and Pumps. This eliminates the possibility of the purified water being re-contaminated by bacteria in any of these units.

DIMENSIONAL DATA

Figure 1 – Bio-Logic® Dimensional Drawing

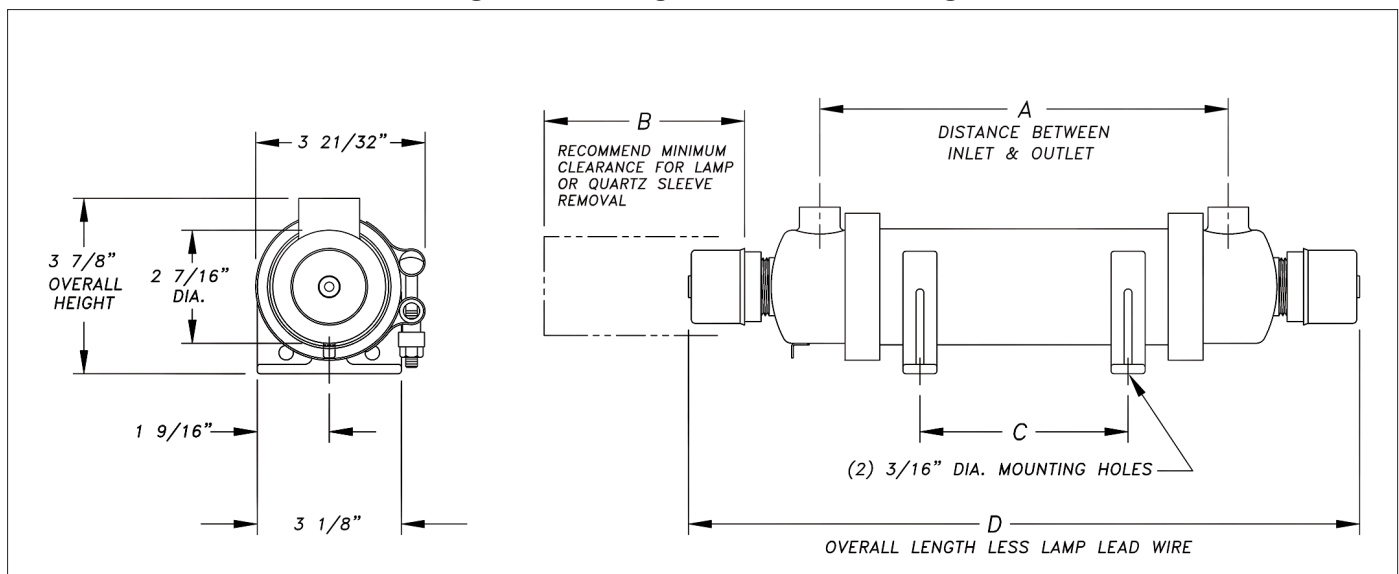

Table 2 – Bio-Logic® Dimensional Data

Model	A	B	C	D	Inlet/Outlet
BIO-1.5	8-13/16"	13-7/8"	3" to 6"	14-1/2"	3/8"FNPT
BIO-3.0	14-7/16"	19-1/2"	6" to 11"	20-1/8"	3/8"FNPT

All specifications, dimensional data, etc are approximate and subject to change without notice.

RECOMMENDED INSTALLATION

Figure 2 – Recommended Installation

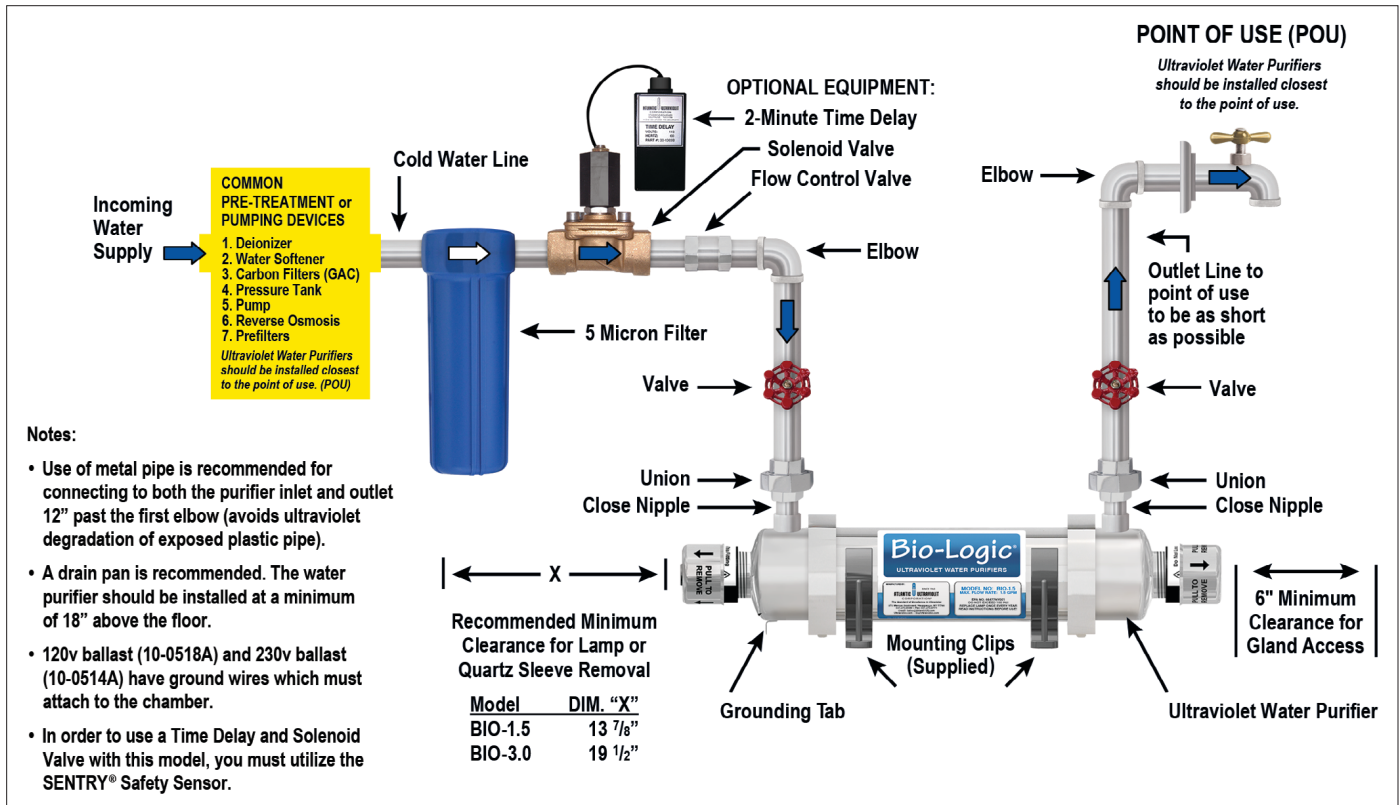

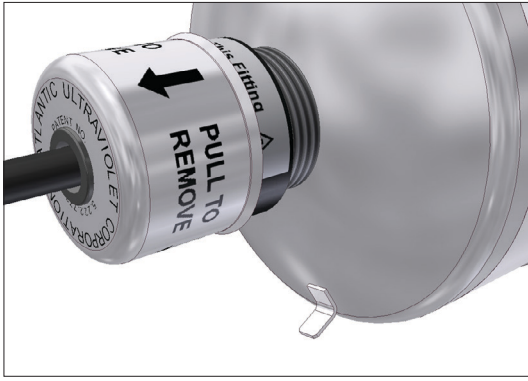

Locate grounding tab

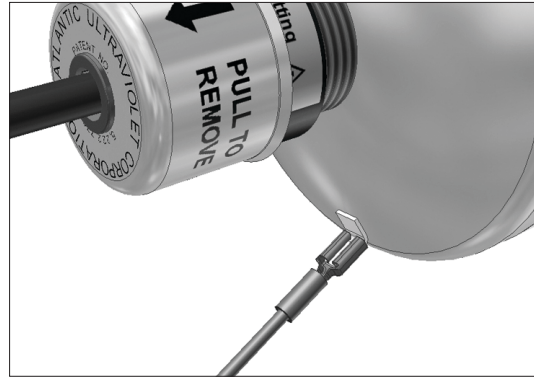

Slide grounding connector over grounding tab

10. Plug ballast into an approved Ground Fault Circuit Interrupt (GFCI) receptacle. Where a 2-prong or unprotected 3-prong receptacle is encountered, it must be replaced by a properly grounded Ground Fault Circuit Interrupt (GFCI) receptacle. Installation must be in accordance with the National Electrical Code and any local codes and ordinances by a qualified Electrician.
11. Once the plumbing hook ups are made, it is a good practice to disinfect the “downstream” plumbing between the purifier and point of use. This is done by introducing chlorine or other disinfectant solution directly into the purifier chamber, a 100-ppm of chlorine is suggested. With the disinfectant solution in the purifier chamber, turn the ultraviolet purifier on. Open the “downstream” outlet until a chlorine or disinfectant solution odor is noticed. Close the outlet and allow the disinfectant to remain in the plumbing for at least three (3) hours. Flush the plumbing with ultraviolet purified water; allow the water to run for a minimum of 5 minutes before use (to ensure no chlorine or disinfectant solution smell can be detected), this will allow the chlorine or disinfectant solution to be flushed through the pipes.

CAUTION For added protection, a suitable drain pan must be installed under the purifier. The drain pan must be plumbed to an adequate, free flowing drain to prevent water damage in the event of a leak. There are numerous leak detection/flood stop devices, available on the market today, designed to stop the flow of water, reducing the chance of water damage due to leakage. For more details regarding leak prevention and/or limiting damages due to leaks, please contact the factory.

RECOMMENDED OPTIONS

12. **SENTRY™ Safety Sensor:** Indicators provide constant visual monitoring of normal operation. In the event of ballast or lamp failure the safety sensor indicates an alarm condition. The safety sensor is capable of operating an optional audio alarm and/or solenoid valve.
13. **Promate™ Audio Alarm:** Activated by the Ultraviolet Monitor or Safety Sensor, alerts the user to any malfunction detected.
14. **Promate™ Time Delay Mechanism:** Provides a 2-minute warm up period during which the ultraviolet lamp achieves its full germicidal output before the water is allowed to flow through the water purifier. The time delay mechanism is used in conjunction with, and is electrically connected to the Solenoid Valve.
15. **Promate™ Solenoid Valve:** Operated in conjunction with the Ultraviolet Monitor, Safety Sensor or Time Delay Mechanism, this valve prevents water flow through the water purifier when an abnormal condition is detected or in the event of power failure.
16. **SureFLO™ Flow Control Valve:** Limits water flow to the rated capacity of the purifier. The flow control valve is located in line prior to the water purifier, and should be protected from ultraviolet exposure by the use of a 90-degree elbow fitting between the flow control valve and the water purifier. *Unless otherwise specified PVC flow control valves are supplied. Stainless Steel Flow Control Valves are available for certain models. All PVC and Stainless Steel flow control valves are male NPT Consult Factory for other flow control valves*
17. **Promate™ Elapsed Time Indicator:** A non-resettable display of the water purifier operating hours. Useful for scheduling and recording maintenance and lamp replacement.
18. **Promate™ Safety Glasses:** Safety eyewear **MUST** be used as general-purpose safety protection and for additional shielding from ultraviolet rays
19. **Promate™ Face Shield:** Lightweight visor with adjustable headgear provides eye and face protection from ultraviolet rays.

NOTE: The recommended options above are available from Atlantic Ultraviolet Corporation® or a distributor of their products. For the other devices that may be required for your application, please contact your local water treatment dealer, plumber or plumbing supplier.

MAINTENANCE

The water purifier is designed to operate with a minimal amount of maintenance, providing the water quality does not exceed maximum concentration levels, see “**Water Quality**” in the “**Product Application**” section on **Page 4**.

Ordinary maintenance consists of;

- Lamp replacement is recommended every 10,000 hours of operation, approximately 12 months of continuous service.
- Cleaning of the quartz sleeve, when conditions warrant. It is recommended that the inspection of quartz sleeve be performed after one month of use. If quartz sleeve is found to be coated (not clear), then frequency of cleaning must be done more often. Deposits or discoloration on the surface of quartz sleeve are caused by excessive levels of the subject contaminant within the water that is in contact with the quartz sleeve. Most deposits on the quartz sleeve are caused by an excess of calcium (hardness), iron or manganese. Table 1 on Page 4 lists the maximum recommended concentration of these minerals in the water that passes through the ultraviolet purifier. If you encounter difficulty due to deposits on the quartz sleeve, your dealer will be able to recommend suitable pretreatment to reduce or eliminate the offending contaminant. If quartz sleeve is clean (clear) then frequency of cleaning may be extended.
- Always disconnect the water supply and completely drain the water purifier if it will be subjected to temperatures below freezing.
- Contact factory with questions.

INSPECTION

1. Regularly inspect the water purifier to ensure that the germicidal lamp is still in operation.
 - An LED indicator light, located on the ballast, provides visual indication of germicidal lamp operation. This provides an indication of lamp operation and does not indicate the level of ultraviolet intensity or transmission through the water.
 - Ballasts have a built-in audio alarm which will indicate lamp failure.
 - On purifiers so equipped, the **SENTRY™** Safety Sensor provides visual indication of ballast and ultraviolet lamp operation
2. To ensure proper operation of the water purifier, regular biological testing of the purifier output water should be performed on a schedule recommended by local public health authorities, or at minimum; at installation, quarterly for the first year of service and annually, at lamp replacement, for the life of the water purifier.
3. Additional testing should be performed whenever modifications, change or additions are made to plumbing system, pumps, well source water etc. to ensure adequate disinfection under new condition.
4. As with any water purifier installation, routine maintenance is necessary to ensure your equipment is operating correctly. Regular inspection must also include the inspection of the ground to ensure grounding wires are secure to both the water purifier and grounding point as originally installed. Regular inspection must also include confirmation that approved ground fault circuit interrupt (GFCI) receptacle is still operational and that water purifier is plugged into this GFCI. Any components which are damaged, or broken should be replaced.

LAMP INSTALLATION OR REPLACEMENT BIO-1.5 AND BIO-3.0 USING BALLAST NO.10-0518A 120V 50/60HZ AND USING BALLAST NO.10-0514A 230V 50/60HZ



IN ORDER TO PERFORM THIS TASK, BE SURE TO WEAR THE FOLLOWING SAFETY EQUIPMENT: SAFETY GLASSES OR A FACE SHIELD, AS WELL AS GLOVES.

Figure 4 – Lamp Replacement for BIO-1.5 and BIO-3.0 (ballast no 10-0518A or 10-0514A)

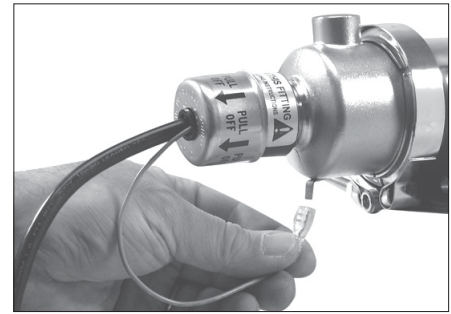
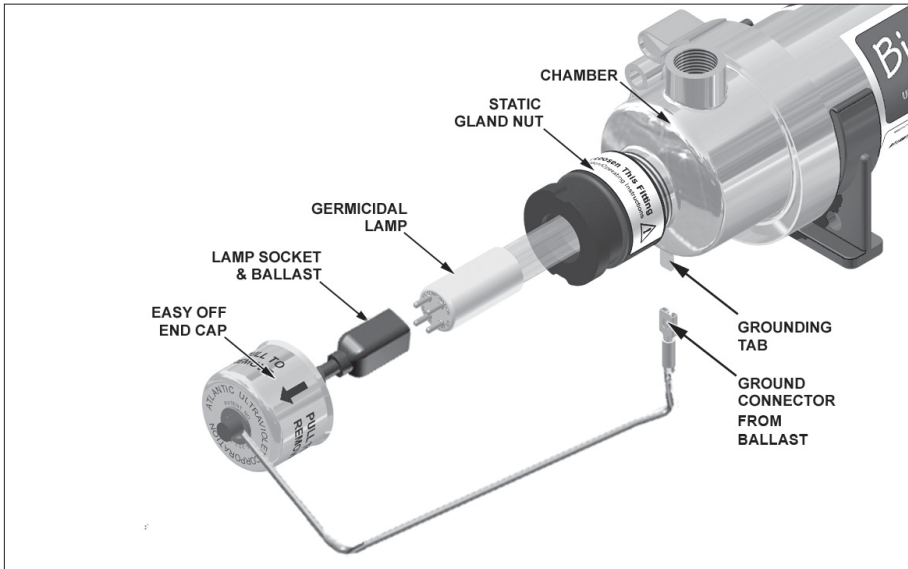

Step 1 - Disconnect Power to Water Purifier and Remove Ground Connector

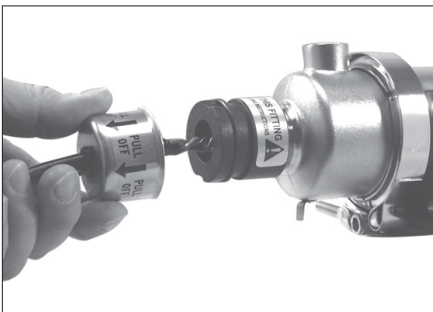

Step 2 - Remove End-Cap



Step 3 - Remove Socket

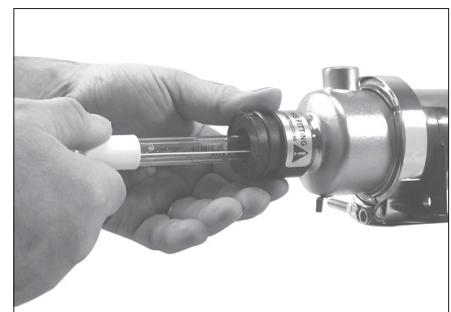

Step 4 - Remove Lamp

1. **⚠ WARNING** Disconnect power to water purifier, and remove ground connector from the chamber.
2. Remove **EASY-OFF™** End Cap by pulling cap off static gland nut.
3. Pull lamp cord and carefully withdraw lamp approximately 2 inches from chamber. While holding lamp end, remove lamp socket from exposed lamp end.
4. Carefully withdraw lamp from chamber. Be sure to withdraw lamp straight out without angling until completely clear of quartz sleeve.

⚠ CAUTION Lamp and quartz sleeve are easily damaged. Exercise care when handling.

5. Reinstall lamp in reverse order.

⚠ WARNING Germicidal ultraviolet rays are harmful to eyes and skin. Do not restore power to water purifier until lamp and both **EASY-OFF™** End Caps have been properly reinstalled.

QUARTZ SLEEVE INSTALLATION, CLEANING, OR REPLACEMENT

Figure 5 – BIO-1.5 & BIO-3.0 120v 50/60Hz (ballast no. 10-0518A)

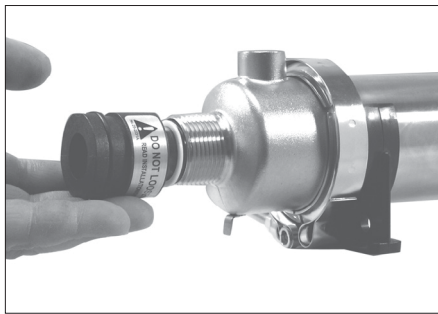
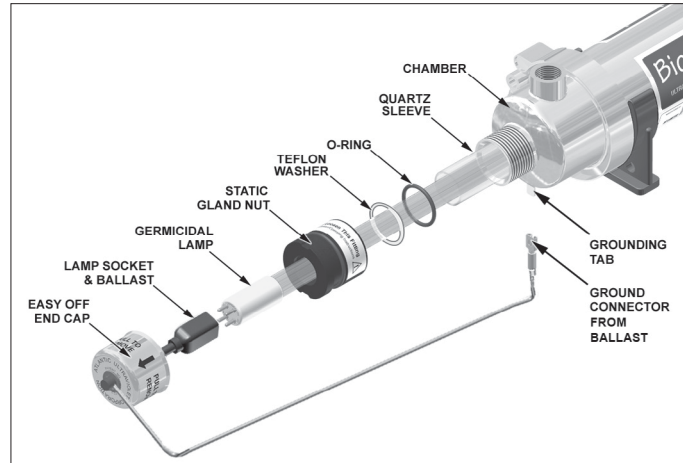

Step 4 - Remove Gland Nut From Each End

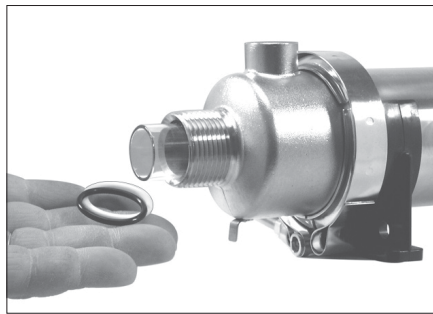

Step 5 - Remove Washer & O-Ring From Each End

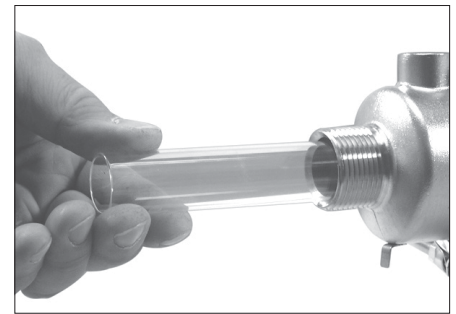

Step 6 - Remove Quartz Sleeve



IN ORDER TO PERFORM THIS TASK, BE SURE TO WEAR THE FOLLOWING SAFETY EQUIPMENT: SAFETY GLASSES OR A FACE SHIELD, AS WELL AS GLOVES.

- ⚠ WARNING** Disconnect power to water purifier.
 - For 120v 50/60Hz version using ballast no. 10-0518A or 230v 50/60hz version using ballast no. 10-0514A, remove the ground connector from the chamber, and go to the next step.
- Shut off water supply to water purifier via inlet and outlet shut off valves and drain chamber.
- Follow the steps in “Lamp Installation or Replacement” to remove lamp.
⚠ CAUTION Lamp and quartz sleeve are easily damaged. Exercise care when handling.
- Unscrew static gland nuts from each end of the chamber. Avoid striking quartz sleeve with static gland nut.
- Remove Teflon® washer and O-Ring from both ends of quartz sleeve. Teflon® washer will sometimes remain within the static gland nut. If so, remove Teflon® washer from static gland nut before proceeding.
- Carefully remove quartz sleeve from chamber. **NOTE:** It is advisable to support the quartz sleeve on the opposite end with your finger so that it does not drop to the bottom of the chamber as it slides into the chamber.
- Once the quartz sleeve is removed, clean with alcohol or a mild, non-abrasive detergent. Stubborn stains usually can be removed with a dilute hydrochloric acid. **NOTE:** Follow all manufacturer’s instructions and precautions when handling chemicals.
- Reassemble in reverse order. Make sure the quartz sleeve protrudes an equal distance past each threaded nipple. Be sure O-Rings are placed on quartz sleeve before Teflon® washer.
- Tighten static gland nuts firmly by hand only, **DO NOT USE HAND TOOLS**. Tightening with hand tools is likely to cause quartz sleeve to break.
- Slowly restore water supply to water purifier and check for leaks.
- If no leaks occur, reinstall lamp, following the steps in “Lamp Installation or Replacement” section.

⚠ WARNING Germicidal ultraviolet rays are harmful to eyes and skin. Do not restore power to water purifier until lamp and both EASY-OFF™ End Caps have been properly reinstalled.

REPLACEMENT OF BROKEN QUARTZ SLEEVE

Figure 6 – Chamber Head Removal

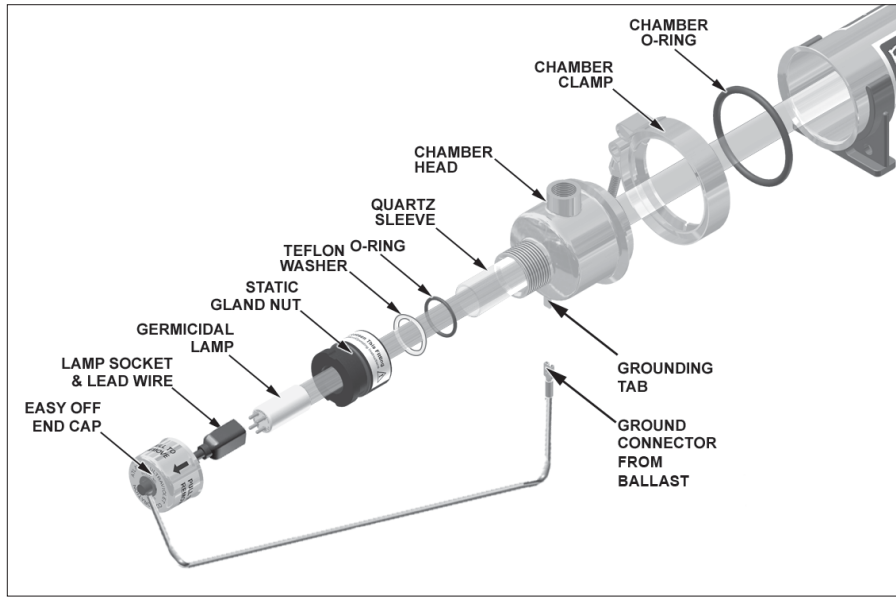

IN ORDER TO PERFORM THIS TASK, BE SURE TO WEAR THE FOLLOWING SAFETY EQUIPMENT: SAFETY GLASSES OR A FACE SHIELD, AS WELL AS GLOVES.

CAUTION Broken Quartz is SHARP. It is recommended that protective glasses and gloves are worn when handling.

1. **WARNING** Disconnect power to water purifier.
 - For 120v 50/60Hz version using ballast no. 10-0518A or 230v 50/60hz version using ballast no. 10-0514A, remove the ground connector from the chamber, and go to the next step.
2. Shut off water supply to water purifier via inlet and outlet shut off valves and drain chamber.
3. Follow the steps in “Lamp Installation or Replacement” to remove lamp.
4. Unscrew static gland nuts from each end of the chamber. Avoid striking quartz sleeve with static gland nut.
5. Remove Teflon® washer and O-Ring from both ends of quartz sleeve. Teflon® washer will some times remain within the static gland nut. If so, remove Teflon® washer from static gland nut before proceeding.
6. **CAUTION** Carefully remove as much of the broken quartz sleeve as possible, from each end of the chamber.
7. To remove fragments of quartz sleeve, hold the purifier vertically and shake. The quartz fragments will break and drop out of the purifier through the gland fitting. Flush water through chamber being careful to remove all quartz fragments from the interior of the chamber.
8. Carefully discard all pieces of the broken quartz sleeve.
9. Align the end of the quartz sleeve with the gland fitting of the chamber.
10. Carefully slide the quartz sleeve into the chamber, guiding it through the gland fitting. **NOTE:** Use care to keep the quartz sleeve parallel to the chamber, angling the quartz sleeve in any direction could result in the breakage of the quartz sleeve.
11. As the quartz sleeve nears the far end of the chamber, support the quartz sleeve by inserting your finger through the far end gland fitting and into the quartz sleeve. This will minimize the possibility of breaking the quartz sleeve as it passes through the gland fitting.
12. Center the quartz sleeve in the chamber, making sure the quartz sleeve protrudes an equal distance past each threaded gland fitting, of the chamber.
13. Re-install O-Rings, Teflon® washers, and static gland nuts. Be sure O-Rings are placed on quartz sleeve before Teflon® washer. Tighten static gland nuts firmly by hand only, **DO NOT USE HAND TOOLS.** Tightening with hand tools is likely to cause quartz sleeve to break.
14. When all connections are complete allow water to enter the water purifier at a low flow rate until the purifier is pressurized. With the purifier pressurized, it should be checked for leaks.
15. If no leaks occur, reinstall lamp, following the steps in “Lamp Installation or Replacement” section.

DISPOSAL OF MERCURY ADDED LAMPS



Germicidal ultraviolet lamps, like standard fluorescent lamps contain small amounts of mercury. Mercury added lamps should not be placed in the trash. Dispose of properly. For further information regarding the disposal and recycling of lamps containing mercury, along with Federal and State requirements visit LampRecycle.org. For more information on **STER-L-RAY®** Germicidal Ultraviolet Lamps, visit AtlanticUltraviolet.com or Ultraviolet.com.

TROUBLESHOOTING

⚠️ WARNING Always disconnect power to the water purifier before performing any service or maintenance.

IMPORTANT: This unit is to be serviced **ONLY** by qualified, and appropriately licensed, personnel.

Table 3 – Troubleshooting

Problem	Possible Cause	Corrective Action
Purifier not operating	No electrical power	Verify that the purifier is connected to a live power source.
Water leaking from purifier	Cracked or broken quartz sleeve	Shut down purifier, drain, and replace quartz sleeve. See “ Quartz Sleeve Installation, Cleaning, or Replacement ” or “ Replacement of Broken Quartz Sleeve ” in the “ Maintenance ” section.
	Quartz sleeve sealing O-Ring(s) worn, damaged	Shut down purifier, drain, and remove static gland nut, replace sealing O-Ring. See “ Quartz Sleeve Installation, Cleaning, or Replacement ” in the “ Maintenance ” section.
	Poor, or loose, connections or fittings	Tighten suspect connection or fitting; or shut down purifier, drain, and remove fitting or connection. Clean threads; reapply thread sealing tape and reinstall.
Poor purifier disinfection performance	Quartz sleeve fouled	Clean quartz sleeve, see “ Quartz Sleeve Installation, Cleaning, or Replacement ” in the “ Maintenance ” Section.
	STER-L-RAY® Germicidal Lamp output depreciating	Replace lamp, as it nears its end of life (EOL). See “ Lamp Installation or Replacement ” in the “ Maintenance ” section.
	STER-L-RAY® Germicidal Lamp not functioning	Replace lamp. See “ Lamp Installation or Replacement ” in the “ Maintenance ” section.
	Low input voltage	Verify input voltage to purifier.
	Change in water quality	Have water tested to confirm that it does not exceed maximum recommended concentration levels for use with this purifier.

BALLAST No. 10-0518A AND 10-0514A HAVE LAMP-OUT PROTECTION

If power is applied to the ballast without a lamp connected to the circuit or if the lamp fails, the ballast’s lamp-out protection will prevent the ballast from operating, and a red LED light will illuminate and audio alarm will sound. **To reset: disconnect the ballast from power and reconnect or replace the lamp.** The ballast must remain disconnected from power for (2) minutes to reset. After 2 minutes, restore input power. Ballast should resume proper operation.

⚠️ WARNING The equipment that this ballast is used with requires connection to a known good ground. It is the User’s responsibility to ensure that their equipment is properly grounded in compliance with the National Electrical Code and any applicable local codes. Equipment wiring and hook up should be performed by a qualified, licensed electrician. Failure to comply with this requirement could result in serious injury or death.

TECHNICAL SPECIFICATIONS

Table 4 – Technical Specifications

Model:	BIO 1.5	BIO 3.0
Flow Rate (GPM):	1.5	3.0
Inlet\Outlet Size:	3/8"FNPT	3/8"FNPT
Number of Lamps:	1	1
Lamp Model No.:	05-1366-R	05-1370-R
Quartz Sleeve:	1	1
Length:	14-1/2"	20-1/8"
Width:	3-21/32"	3-21/32"
Height:	3-7/8"	3-7/8"
Voltage: ①	120v 50/60Hz	120v 50/60Hz
Chamber Diameter:	2-7/16"	2-7/16"
Shipping Weight:	7.2 lbs.	7.7 lbs.
Power Consumption: ②	14 Watts	21 Watts
Max Operating Pressure:	100 PSI	100 PSI
Ambient Temperature:	35° F–100° F	35° F–100° F

① 220v 50Hz, 220v 60Hz, 12v, or 24v DC units are also available. Consult Factory for specific voltage requirements.

② Total power consumption, including ballast loss (based on 120V unit).

All specifications, dimensional data, etc are approximate and subject to change without notice.

OPTIONAL ACCESSORIES

Optional accessories are available for operation at 120v 60Hz or 230v 50/60Hz. Please specify. Consult Factory for special input power requirements.

Table 5 – Optional Accessories

Optional Accessories	Available for:
SENTRY™ Safety Sensor	BIO-1.5 – BIO-3.0
Promate™ Time Delay Mechanism	BIO-1.5 – BIO-3.0
Promate™ Elapsed Time Indicator, Universal Input	BIO-1.5 – BIO-3.0
Promate™ Solenoid Valve	BIO-1.5 – BIO-3.0
SureFLO™ Flow Control Valve ①	BIO-1.5 – BIO-3.0
Promate™ Audio Alarm	BIO-1.5 – BIO-3.0

① Unless otherwise specified, PVC flow control valves are supplied. Stainless Steel Flow Control Valves are available for certain models. All PVC and Stainless Steel flow control valves are male NPT. Consult Factory for other flow control valves.



⚠️ WARNING 12 Volt and 24 Volt Direct Current (DC) Ballasts and Units

Many individuals regard ballasts and units powered by 12 volt and 24 volt Direct Current (DC) to be relatively benign from a safety standpoint. However, a DC ballast, in order to operate an ultraviolet discharge lamp, must produce an output as high as 600 volts. This voltage is high enough to produce a very serious or even lethal electric shock. **IT IS IMPERATIVE** that all DC ballasts and DC ultraviolet units be wired and grounded appropriately.

REPLACEMENT PARTS

Figure 7 – Exploded View

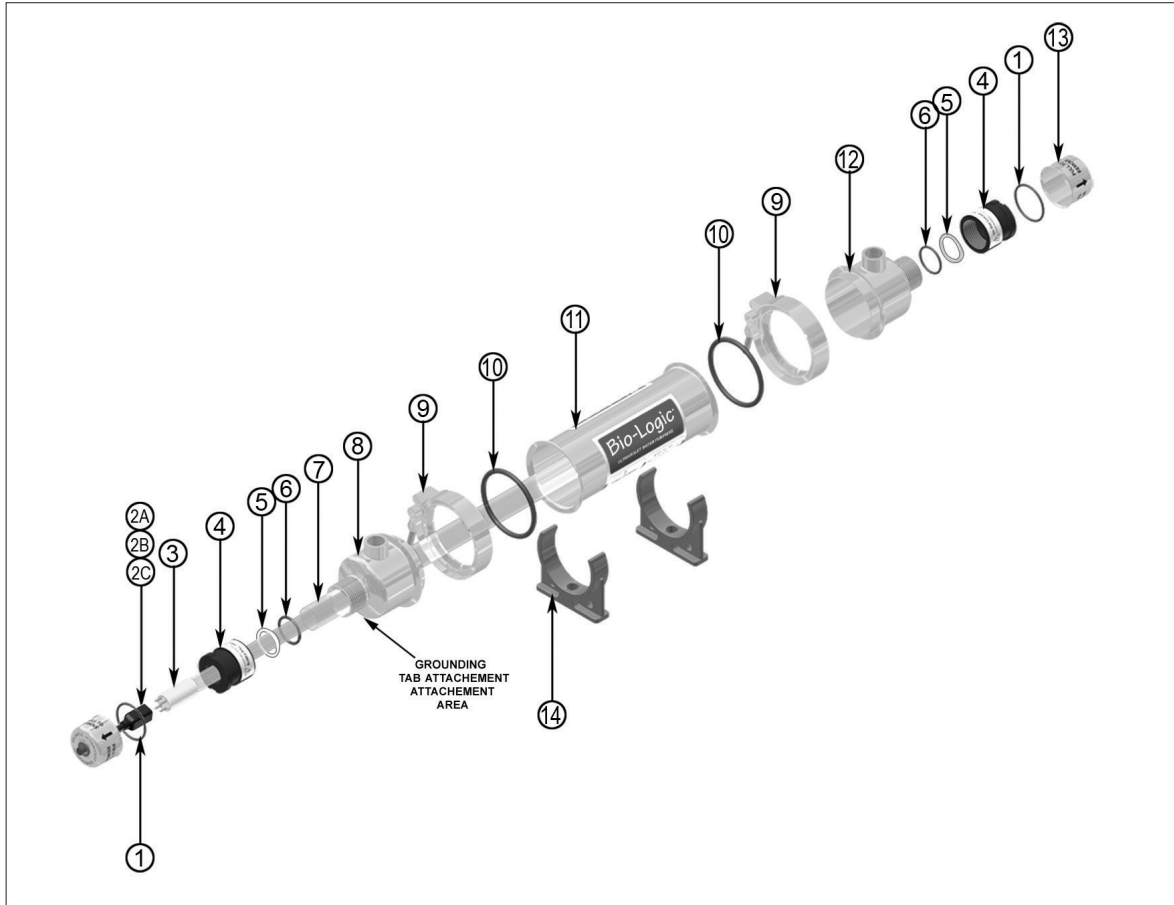

Table 6 – Replacement Parts BIO-1.5 to BIO-3.0

Item No.	Description	Quantity	BIO-1.5	BIO-3
1	Rubber O-Ring, Static Gland	2	00-1108B	00-1108B
2A	Steadfast™ Lamp Socket & Surelite™ Ballast, 120v 50/60Hz	1	10-0518A	10-0518A
2B	Steadfast™ Lamp Socket & Surelite™ Ballast, 230v 50/60Hz	1	10-0514A	10-0514A
2C	Steadfast™ Lamp Socket & Surelite™ Ballast, 12v DC*	1	10-1201A	10-1201A
3	STER-L-RAY® Lamp	1	05-1366-R	05-1370-R
4	Static Gland Nut	2	25-1492D	25-1492D
5	Teflon® Washer	2	25-3023A	25-3023A
6	Rubber O-Ring, Quartz Sleeve	2	00-1023A	00-1023A
7	CRYSTAL CLEAR™ Quartz Sleeve	1	15-1700A	15-1701A
8	Chamber Head, 2 ½" with Ground Terminal	1	25-4506A	25-4506A
9	Chamber Clamp	2	25-6009	25-6009
10	Chamber O-Ring	2	00-0250A	00-0250A
11	Chamber Tube	1	25-6004A1	25-6004A2
12	Chamber Head, 2 ½"	1	25-6042	25-6042
13	EASY-OFF™ End Cap with Clear Window Plug	1	25-1398	25-1398
14	Mounting Clip	2	27-0045	27-0045

All specifications, dimensional data, etc are approximate and subject to change without notice.

* Lamp Socket and Ballast not shown

USER ASSISTANCE

Atlantic Ultraviolet Corporation® makes every effort to ensure that the **Bio-Logic**® Germicidal UV Water Purifiers are products of superior quality and workmanship. This manual describes the installation, operation and maintenance of the **Bio-Logic**® Germicidal Ultraviolet Water Purifier.

Please read and become familiar with the contents of this manual before installing or using this unit. If after reading the manual you still have questions, or concerns, regarding the installation or use of this unit, contact our offices, weekdays between 8:30 am and 5:00 pm Eastern Time, at:

Atlantic Ultraviolet Corporation®
375 Marcus Boulevard
Hauppauge, New York, 11788
Tel: (631) 273-0500
Fax: (631) 273-0771
Email: Sales@AtlanticUV.com
Shop: AtlanticUltraviolet.com
Learn More: Ultraviolet.com

PATENT NOTICE

No attempt has been made to determine the patent status of applications illustrated or described in this publication. Inclusion in this publication of any design or method of use, which may be patented, is not to be construed as promoting or sanctioning unauthorized use.

WARRANTY & PRODUCT REGISTRATION

We warrant this product to the original owner to be free from defects in material and workmanship when installed in accordance with Atlantic Ultraviolet Corporation® specifications for a period of time as follows:

UV Water Purifier Chambers – Type 316 stainless steel chambers will have a Twelve (12) year Limited Warranty on the stainless steel chamber, from the date of original purchase while the Type 304 stainless steel chambers will have a Six (6) year Limited Warranty on the stainless steel chamber.

UV Air Disinfection Housing – Three (3) year Limited Warranty on the metal housing, from the date of original purchase.

Ballasts – Three (3) year Limited Warranty, from the date of original purchase.

UV Lamps, Monitoring Devices, Optional Accessories, and Other Parts – One (1) year Limited Warranty from the date of original purchase.

Within the warranty period we shall repair or replace such products, which are returned to us with shipping charges prepaid and which are determined by us to be defective. This warranty will not apply to any product, which has been subjected to misuse, negligence or accident; or misapplied; or modified; or repaired by unauthorized person; or improperly installed. Warranty will be null and void if any of the product's original labels are removed. This Limited warranty excludes the cost of labor.

The Buyer shall inspect the product promptly after receipt and shall notify us at our main office in writing of claims, including claims of breach of warranty, within thirty (30) days after the Buyer discovers or should have discovered the facts upon which the claim is based. Failure of the Buyer to give written notice of a claim within the time period shall be deemed to be a waiver of such claim.

The provisions of the above warranty are our sole obligation and exclude all other remedies or warranties, expressed or implied, including warranties of merchantability and fitness for a particular purpose, whether or not purposes or specifications are described herein. We further disclaim any responsibility whatsoever to the customer, or to any person for injury to person, damage to, or loss of property or value caused by any product which has been subjected to misuse, negligence, accident; or modified or repaired by unauthorized persons; or improperly installed.

Under no circumstances shall the Company be liable for any incidental, consequential or special damages; losses or expenses arising from the contract for this product, or in connection with the use of, or inability to use, our product for any purpose whatsoever.

Be sure to register your product and validate purchase within 30 days — registration is simple and will take less than 2 minutes to do.

NOTE – failure to register your purchase may jeopardize warranty.

Go to AtlanticUltraviolet.com and scroll down to the bottom of the page, under “Trust” click the “Warranty Registration Form”, complete and click “Submit”. Or click on “Warranty Registration PDF” to download the warranty registration card as a PDF, complete and mail to us at 375 Marcus Boulevard, Hauppauge, NY 11788, or simply fax to (631) 273-0771. If you prefer to register by phone, please call (631) 273-0500 and our customer service staff will be glad to assist you.

For your convenience, record the following information below. The model and serial number can be found on a label located on the **Bio-Logic**® Germicidal Ultraviolet Water Purifier. Keep this manual, along with proof of purchase, handy when contacting our offices.

Purchased From:	Date:
Model:	Serial No.: